

## MDTE Series

### Wire Wound Molded SMD Power Inductors Size 32251B

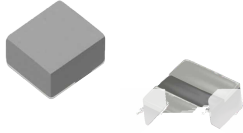

#### FEATURES

- So saturation
- High current, low DCR, high efficiency
- Very low acoustic noise and very low leakage flux noise
- High reliability
- 100% Lead (Pb)-Free and RoHS compliant
- Operating temperature -40~+125°C (Including self-temperature rise)
- Quantity: 3000pcs

#### APPLICATION

- Note PC power system, incl. IMVP-6
- DC/DC converter

#### Dimensions: [mm]

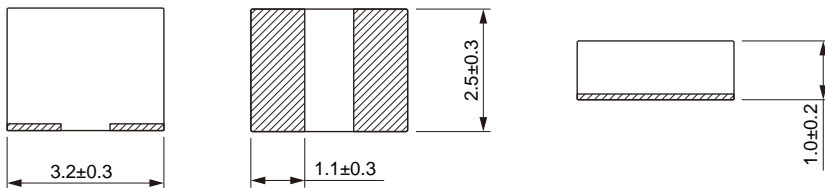

#### Land Pattern: [mm]

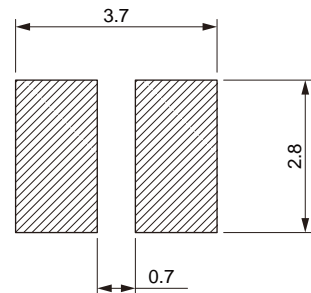

#### Electrical Properties:

	( $\mu\text{H}$ )		Saturation (A)	Saturation (A)	(A)	(A)	(m $\Omega$ )
MDTE32251B-R22M	0.22	±20%	9.3	8.7	9.5	9.0	8.5
MDTE32251B-R33M	0.33	±20%	9.2	8.6	8.5	8.0	12
MDTE32251B-R47M	0.47	±20%	8.3	7.5	7.1	6.6	19
MDTE32251B-R68M	0.68	±20%	7.4	6.9	6.3	5.8	24
MDTE32251B-1R0M	1.00	±20%	6.6	5.8	5.7	5.2	30
MDTE32251B-2R2M	2.20	±20%	4.9	4.4	4.2	3.7	70
MDTE32251B-3R3M	3.30	±20%	3.5	3.1	3.2	2.8	95
MDTE32251B-4R7M	4.70	±20%	2.9	2.5	2.5	2.0	135

Saturation Current will cause L to drop approximately 30%

Temperature Rise Current: The actual value of DC current when the temperature rise is  $\Delta T=40^{\circ}\text{C}$

# Typical Electrical Characteristics:

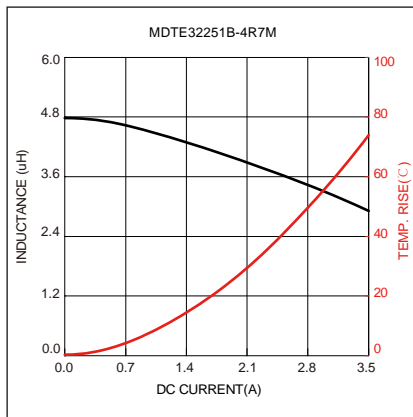
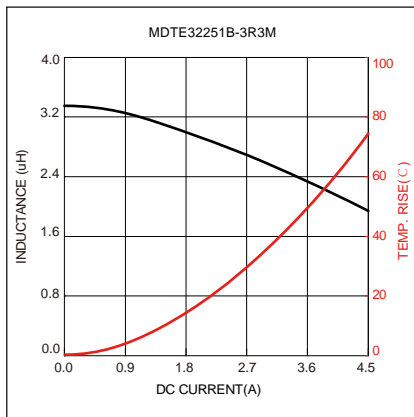
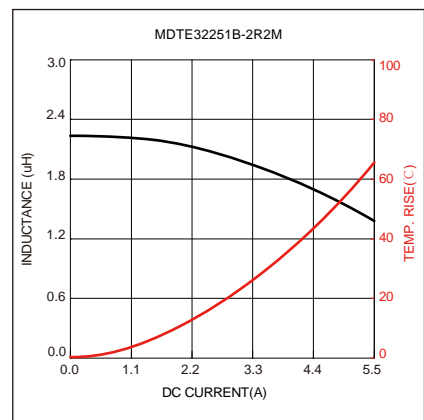
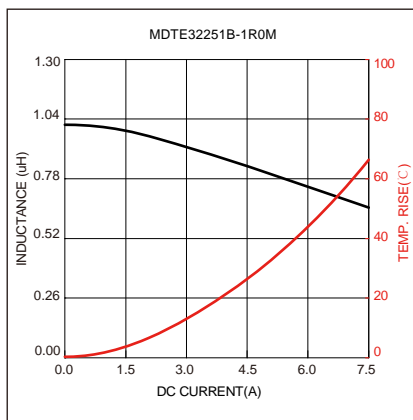
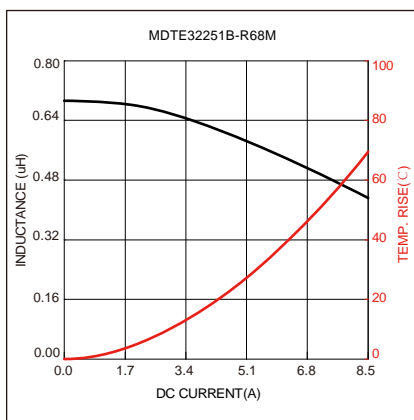
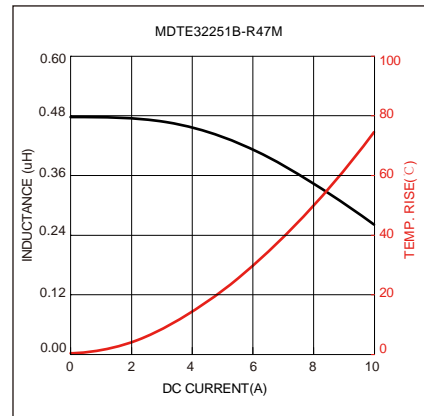
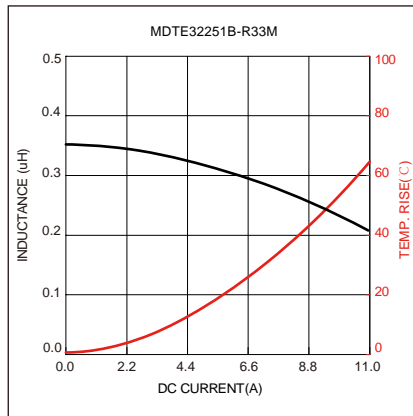
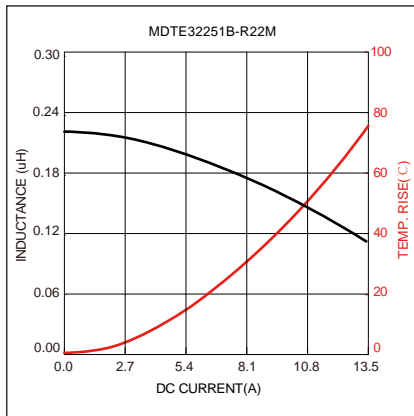

## Soldering Reflow:

## Packaging Information:

### Tape Dimension:

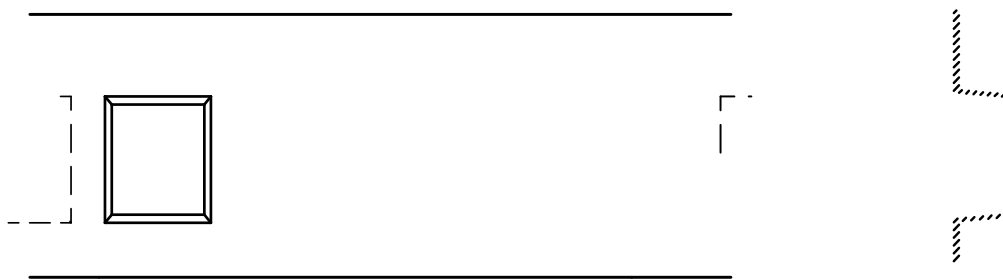

Series	A0 (mm)	B0 (mm)	D (mm)	P0 (mm)	P1 (mm)	W (mm)	K0 (mm)	E (mm)	T (mm)
MDTE32251B	2.9±0.1	3.6±0.1	1.5±0.1	4.0±0.1	4.0±0.1	8.0±0.1	1.4±0.1	1.75±0.1	0.25±0.05

### Peel force of top cover tape:

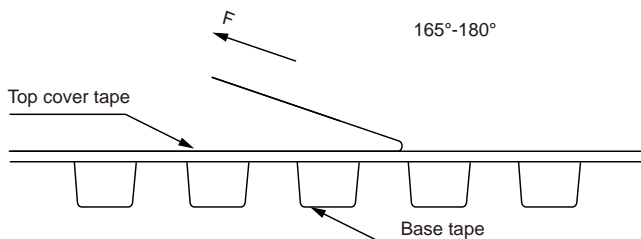

The peel force of top cover tape shall be between 0.1 to 0.98 N

## Reel Dimension: [mm]



## Packaging Quantity:

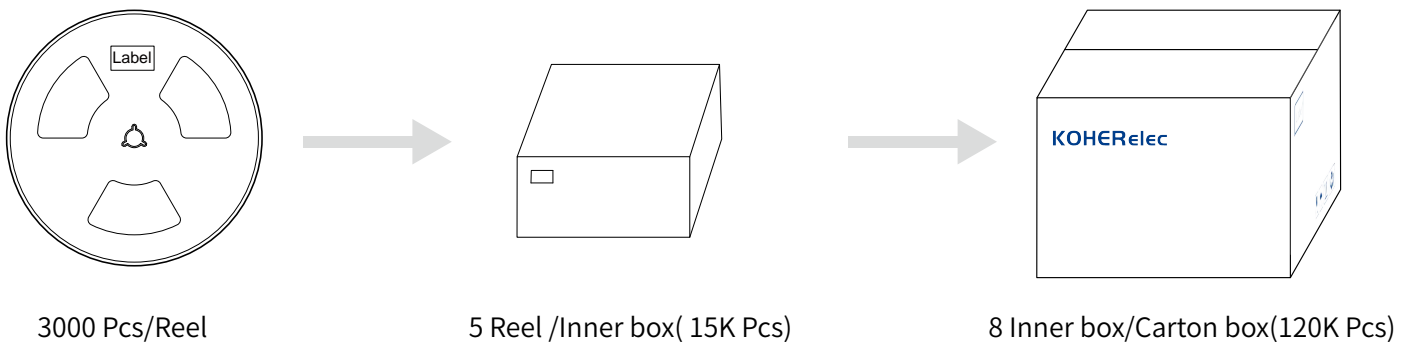

## Cautions and Warnings:

### Storage Conditions:

- The storage period is within 12 months after the completion of production. Be sure to follow the storage conditions (temperature: -5 to 35°C, humidity: 75% RH Max). If the storage period elapses, the soldering of the terminal electrodes may deteriorate. The warranty period is one year.
- Product should not be exposed to environment with high temperature, high humidity, dust, corrosive gas and etc.
- Products should be handled with care to avoid damage or contamination from perspiration and skin oils.
- Please always handle products carefully to prevent any damage caused by dropping down or inappropriate removing.

### Operation Instructions:

- Self heating (temperature increase) occurs when the power is turned ON, so the tolerance should be sufficient for the set thermal design.
- Before soldering, be sure to preheat components. The preheating temperature should be set so that the temperature difference between the solder temperature and chip temperature does not exceed 150°C.
- Soldering corrections after mounting should be within the range of the conditions determined in the specifications. If overheated, a short circuit, performance deterioration, or lifespan shortening may occur.
- Generally, Koher might not be familiar with either customer's specific application or actual requests as customer does. As a result customer shall be responsible for checking and confirming whether Koher product with the performance described in the product specification is suitable for using in customer's particular application or not.