

MDA Series

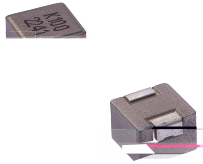

FEATURES

-
-
-
-
-
-
-
-
-

APPLICATION

-
-
-
-
-
-
-

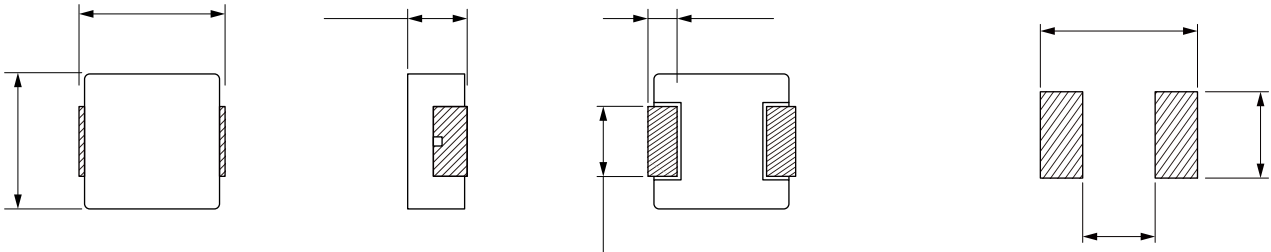

	(μH)			Saturation	($\text{m}\Omega$)

	(μH)			Saturation	($\text{m}\Omega$)

△

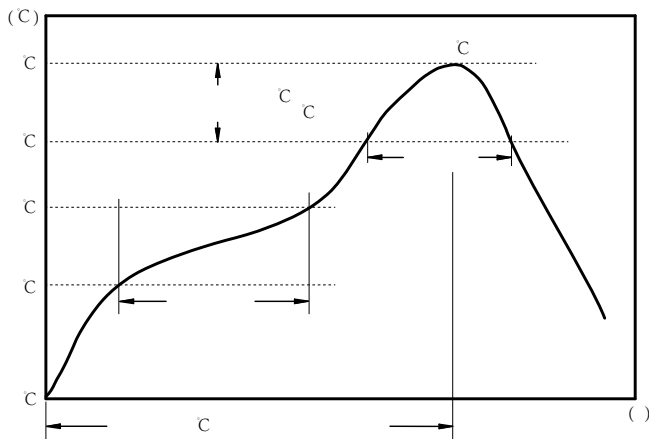

c
c
c

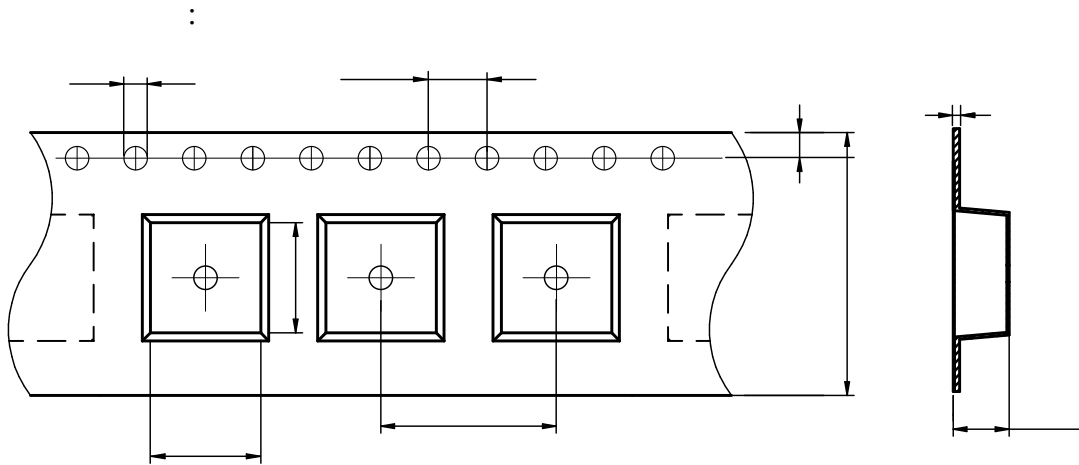

MDA7040	6.9± 0.1	7.5± 0.1	1.5± 0.1	4.0± 0.1	12.0± 0.1	16.0± 0.3	4.3± 0.1	1.75± 0.1	0.40± 0.05

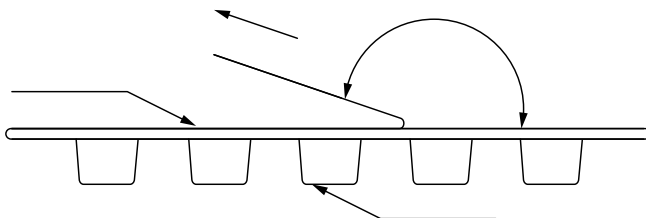

The peel force of top cover tape shall be between 0.1 to 1.3 N

Marking	K+Printing Inductance+period)
---------	-------------------------------

:

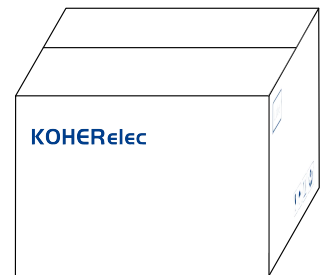
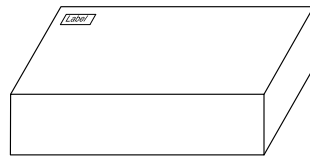
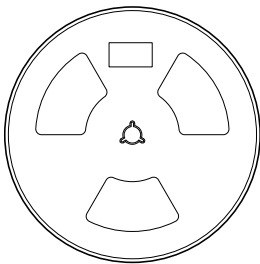
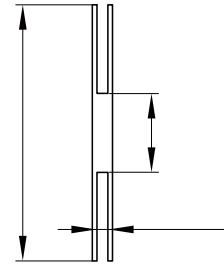
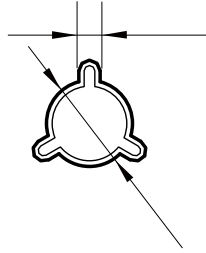
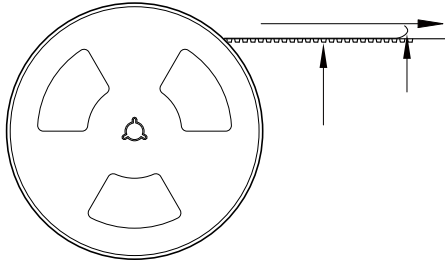

1000Pcs/Reel

2 Reel /Inner box(2K Pcs)

3 Inner box/Carton box(6K Pcs)

:

-
-
-
-
-
-
-
-
-
-